



PRE3

PILOT OPERATED PRESSURE CONTROL VALVE WITH ELECTRIC PROPORTIONAL CONTROL

SERIES 20

SUBPLATE MOUNTING
ISO 4401-03

p max 350 bar
Q max 40 l/min

MOUNTING INTERFACE

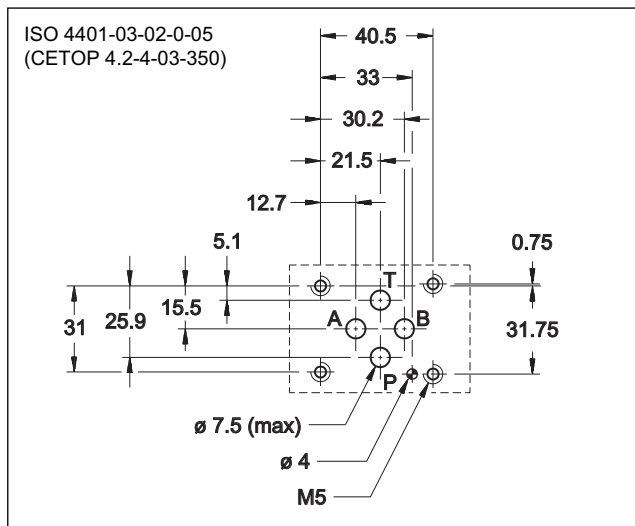

PERFORMANCES

(obtained with mineral oil with viscosity of 36 cSt at 50°C and electronic control card)

Maximum operating pressure: - P port - T port	bar	350 2
Minimum controlled pressure	see p min = f(Q) diagram	
Minimum flow Maximum flow (see graph p max= f(Q))	l/min	2 40
Step response	see paragraph 6	
Hysteresis (with PWM 200 Hz)	% of p nom	< 5%
Repeatability	% of p nom	< ±1,5%
Electrical characteristic	see paragraph 5	
Ambient temperature range	°C	-20 / +60
Fluid temperature range	°C	-20 / +80
Fluid viscosity range	cSt	10 ÷ 400
Fluid contamination degree	According to ISO 4406:1999 class 18/16/13	
Recommended viscosity	cSt	25
Mass	kg	3,5

OPERATING PRINCIPLE

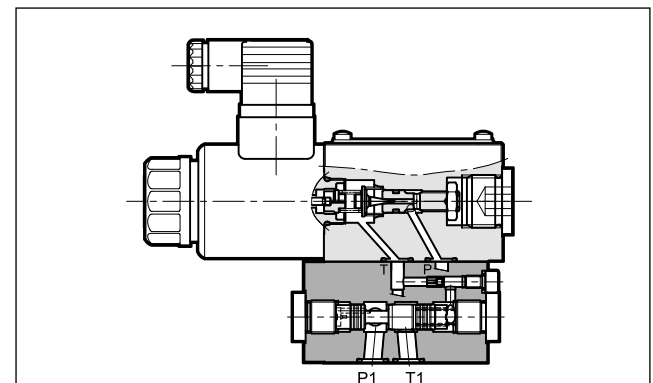

- The PRE3 is a pilot operated pressure control valve with electric proportional control and mounting interface in compliance with ISO 4401 standards.
- It is suitable to modulate the pressure in hydraulic circuits.
- The valve can be controlled directly by a current control supply unit or by an electronic control unit to exploit valve performance to the full (see at paragraph 9).
- The design of this valve has a mechanical pressure limitation feature for higher safety of the application.
- Five pressure control ranges up to 350 bar are available.

HYDRAULIC SYMBOL

simplified

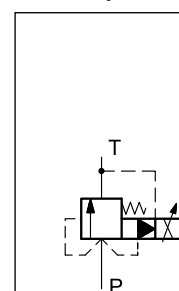

detailed

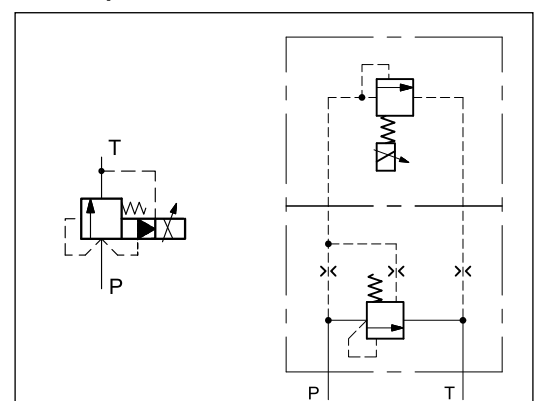

1 - IDENTIFICATION CODE

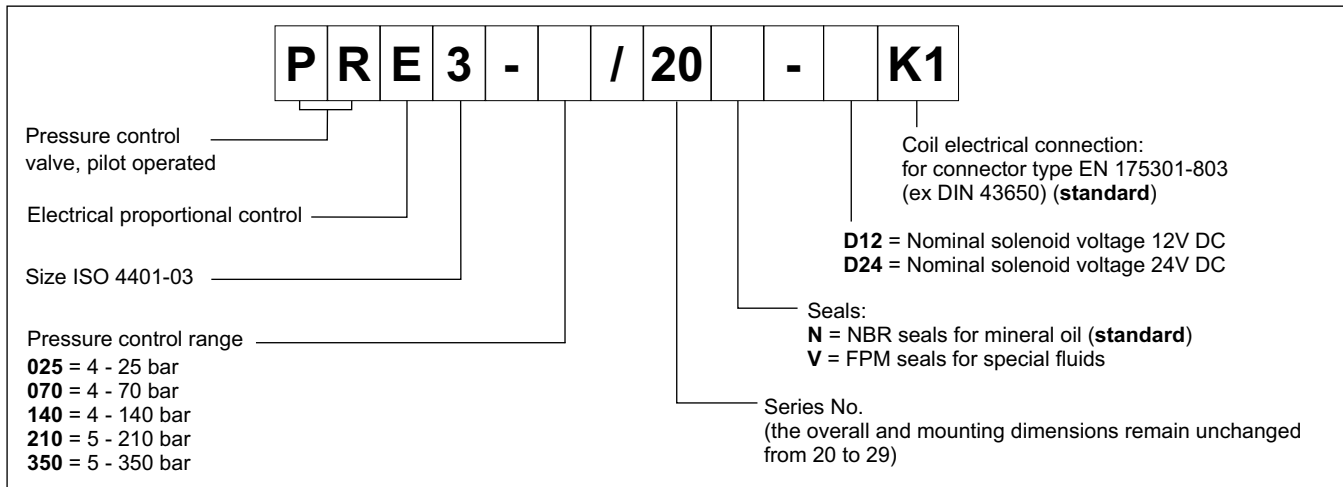

2 - CHARACTERISTIC CURVES

(measured with viscosity of 36 cSt at 50°C)

Typical control curves according to the current supplied to the solenoid (D24 version with maximum current 860 mA) for the available pressure control ranges, measured with input flow rate $Q = 10$ l/min. Curves have been obtained without any hysteresis and linearity compensation and they have been measured without any backpressure in T.

The full scale pressure is set in factory with a flow rate of 10 l/min. In case of higher flow rate, the full scale pressure will increase (see diagram $p_{max} = f(Q)$).

PRESSURE CONTROL $p = f(I)$

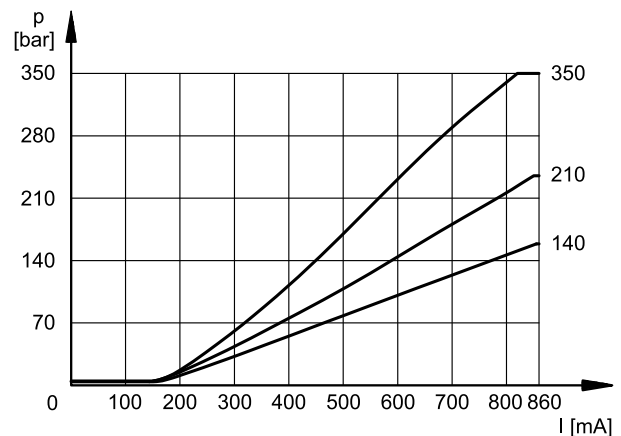
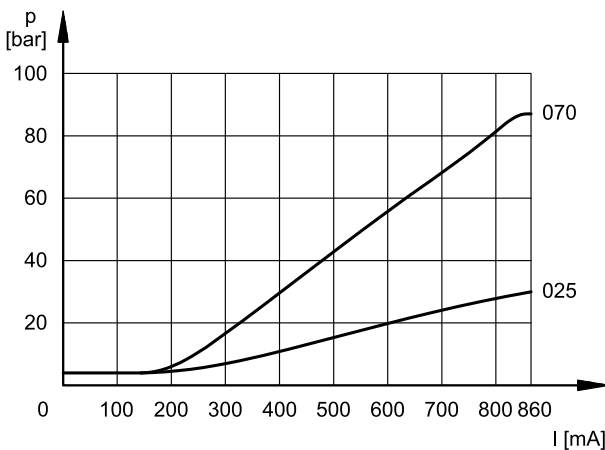

MINIMUM CONTROLLED PRESSURE $p_{min} = f(Q)$

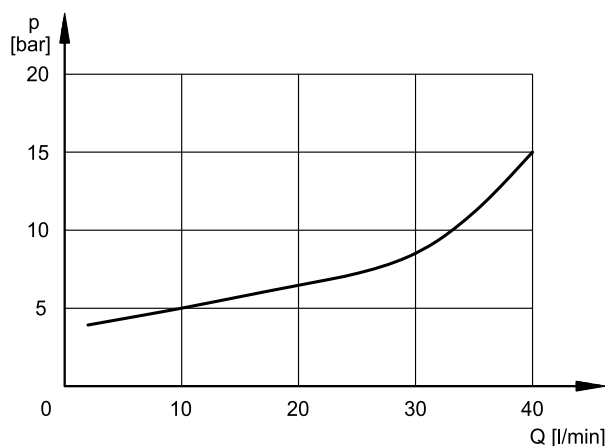

PRESSURE VARIATION $p_{max} = f(Q)$

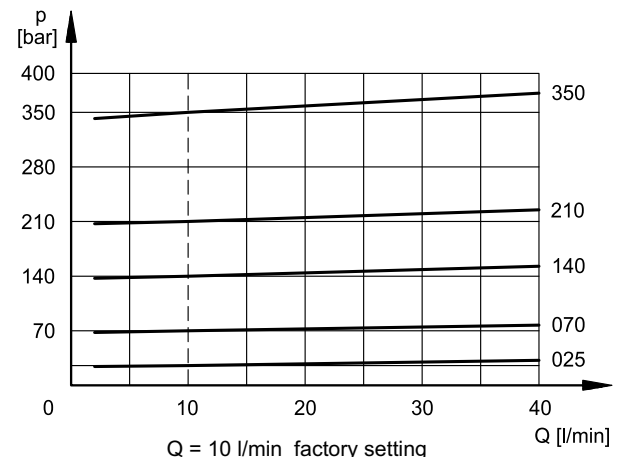

3 - MAX PRESSURE VALUES

This valve incorporates a mechanical limit of the maximum pressure, that operates independently of the applied current. This kind of design ensures the pressure cannot rise over even if the solenoid current exceeds the maximum current ($I > I_{max}$).

Values obtained with oil viscosity of 36 cSt at 50°C, Q = 10 l/min

		PRE3-025	PRE3-070	PRE3-140	PRE3-210	PRE3-350
pressure value at 800 mA	bar	28	82	145	215	335
max pressure value when $I > I_{max}$	bar	30	86	155	230	350

4 - HYDRAULIC FLUIDS

Use mineral oil-based hydraulic fluids HL or HM type, according to ISO 6743-4. For these fluids, use NBR seals (code N). For fluids HFDR type (phosphate esters) use FPM seals (code V). For the use of other fluid types such as HFA, HFB, HFC, please consult our technical department.

Using fluids at temperatures higher than 80 °C causes a faster degradation of the fluid and of the seals characteristics. The fluid must be preserved in its physical and chemical characteristics.

5 - ELECTRICAL CHARACTERISTICS

Proportional solenoid

The proportional solenoid comprises two parts: tube and coil.

The tube, screwed to the valve body, contains the armature which is designed to maintain friction to a minimum thereby reducing hysteresis.

The coil is mounted on the tube secured by means of a lock nut and can be rotated through 360° depending on installation clearances.

NOMINAL VOLTAGE	V DC	12	24
RESISTANCE (at 20°C)	Ω	3.66	17.6
MAXIMUM CURRENT	A	1.88	0.86
DUTY CYCLE	100%		
ELECTROMAGNETIC COMPATIBILITY (EMC)	According to 2014/30/EU		
PROTECTION FROM ATMOSPHERIC AGENTS (IEC 60529)	IP65		
CLASS OF PROTECTION Coil insulation (VDE 0580) Impregnation	class H class F		

6 - STEP RESPONSE

(obtained with mineral oil with viscosity of 36 cSt at 50°C and electronic control card)

Step response is the time taken for the valve to reach 90% of the set pressure value following a step change of reference signal.

The table illustrates typical step response times measured with a PRE3-210 and with input flow rate Q = 10 l/min, and a pressure oil volume of 1 litre. The response time is affected by both the flow rate and the oil volume inside the piping.

REFERENCE SIGNAL STEP	0 → 100%	100 → 0%
Step response [ms]	80	40

7 - INSTALLATION

We recommend to install the PRE3 valve either in horizontal position, or vertical position with the solenoid downward. If the valve is installed in vertical position and with the solenoid upward, you must consider possible variations of the minimum controlled pressure, if compared to what is indicated in paragraph 2.

Ensure that there is no air in the hydraulic circuit. In particular applications, it can be necessary to vent the air entrapped in the solenoid tube, by using the apposite drain screw in the solenoid tube. Ensure that the solenoid tube is always filled with oil. At the end of the operation, make sure of having screwed the drain screw correctly.

Connect the valve T port directly to the tank. Add any backpressure value detected in the T line to the controlled pressure value.

Maximum admissible backpressure in the T line, under operational conditions, is 2 bar.

Valves are fixed by means of screws or tie rods on a flat surface with planarity and roughness equal to or better than those indicated in the relative symbols. If minimum values are not observed, fluid can easily leak between the valve and support surface.

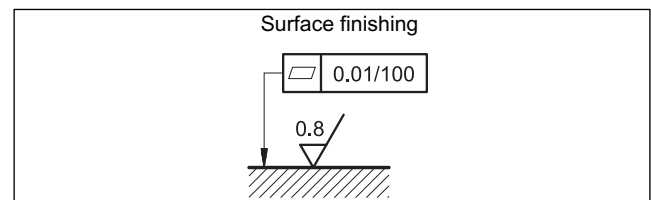

8 - OVERALL AND MOUNTING DIMENSIONS

dimensions in mm

NOTE: at the first start up, or after a long period of no use, it is necessary to vent the air through the breather (3) placed at the end of the solenoid tube.

Fastening bolts: 4 SHC screws M5x70 - ISO 4762	
Torque: 5 Nm (A8.8)	
Threads of mounting holes: M5x10	

1	Mounting surface with sealing rings: 4 OR type 2037 (9.25x1.78) - 90 shore
2	Coil removal space
3	Breather (male hexagonal spanner 4)
4	EN 175301-803 (ex DIN 43650) connector (included in the delivery)
5	Connector removal space

9 - ELECTRONIC CONTROL UNITS

EDC-112	for solenoid 24V DC	plug version	see catalogue 89 120
EDC-142	for solenoid 12V DC		
EDM-M112	for solenoid 24V DC	DIN EN 50022 rail mounting	see catalogue 89 251
EDM-M142	for solenoid 12V DC		

10 - SUBPLATES

(see catalogue 51 000)

PMMD-AI3G with ports on rear
PMMD-AL3G with side ports
Ports dimensions P, T, A and B: 3/8" BSP thread

	<p>DIPLOMATIC MS S.p.A. via M. Re Depaolini 24 • 20015 PARABIAGO (MI) • ITALY tel. +39 0331.895.111 • www.diplomatic.com • e-mail: sales.exp@diplomatic.com</p>
--	--